

# **Genotropin Pen<sup>®</sup> 5**

Growth Hormone Delivery Device for use with Genotropin<sup>®</sup>  
Lyophilized Powder (somatotropin [rDNA origin] for injection)

## Instructions for Use

### Important Note

Please read these instructions completely before using the GENOTROPIN PEN 5. If there is anything you do not understand or cannot do, call the toll-free number listed at the end of these instructions.

If you have any questions about your dose or your treatment with GENOTROPIN, call your healthcare provider.

GENOTROPIN PEN 5 is a device used to mix and inject doses of GENOTROPIN Lyophilized Powder (somatotropin [rDNA origin] for injection). Use this device **only** for administration of GENOTROPIN.

### What You Will Need

- GENOTROPIN PEN 5
- 5mg two-chamber cartridge of GENOTROPIN
- Alcohol swab
- 29-gauge, 30-gauge, or 31-gauge Becton Dickinson pen needle
- Proper disposal container for used needles

### Components of the GENOTROPIN PEN 5

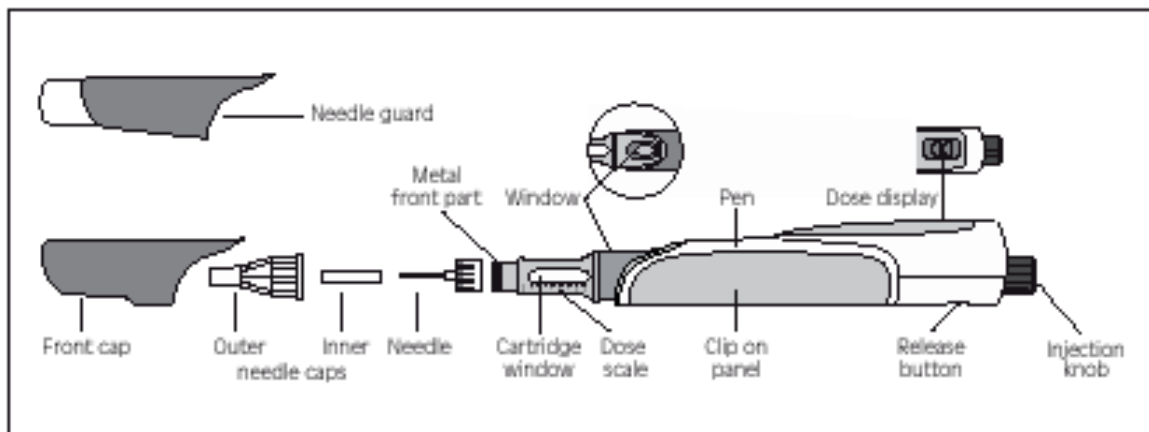

### Before You Begin

To help prevent infection, **always** wash your hands with soap and water before preparing or using the GENOTROPIN PEN 5.

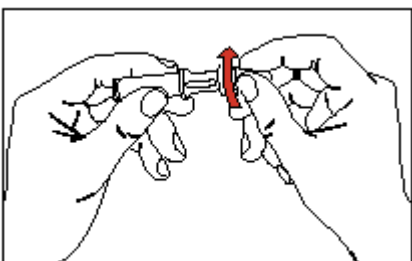

#### 1. **Attach the Needle**

- Remove the front cap from the GENOTROPIN PEN 5.
- Unscrew the metal front part and detach it from the plastic body of the pen.

- Remove the paper covering from the back of a new needle.
- Screw the needle onto the metal front part by gently turning it clockwise (to the right).

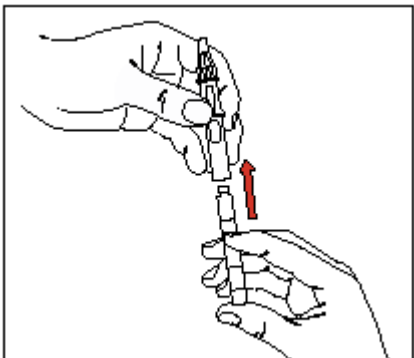

## **2. Insert the Two-Chamber Cartridge of GENOTROPIN**

- Use only the 5 mg cartridge.
- Wipe the metal/rubber tip of the cartridge with an alcohol swab.
- Insert the cartridge into the metal front part of the pen, with the metal/rubber tip towards the needle end. Push the cartridge firmly into place.

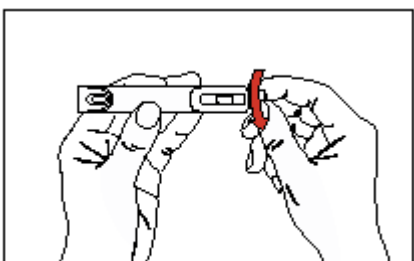

## **3. Prepare the Body of the Pen**

- Press the red release button to release the black/white injection knob.
- **Turn the black/white injection knob counterclockwise (to the left) as far as it will go.**
- Check that the plunger rod is not visible through the window at the top of the plastic body of the pen. **DO NOT** proceed if the plunger rod is visible, as the medication will not be properly mixed. Instead, press the red release button again to draw back the plunger rod. After the rod is no longer visible through the window, proceed to the next step.

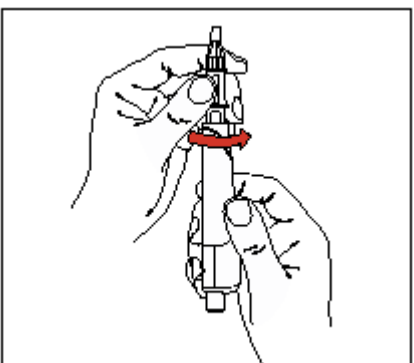

## **4. Screw the GENOTROPIN PEN 5 Together**

- Hold the metal front part upright
- While holding upright, gently screw the metal front part and the plastic body back together. This mixes the diluent in the rear chamber of the cartridge with the growth hormone powder in the front chamber.
- Gently tip the assembled GENOTROPIN PEN 5 from side to side to help dissolve the powder completely. **DO NOT SHAKE** as that might inactivate the growth hormone.

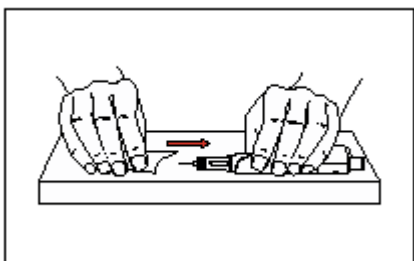

## **5. Examine Solution and Release Trapped Air**

- Look through the cartridge windows in the metal front part of the pen and make sure the drug solution is clear. If you see particles or if the solution is discolored, **DO NOT INJECT IT**. Instead, call the toll-free number listed at the end of these instructions.
- Remove the outer needle cap and save it for later.
- Remove and discard the inner needle cap. **Be careful not to touch the exposed needle.**
- Remove any trapped air from the solution as follows:
  - a) Turn the black/white injection knob clockwise (to the right) one click. This will line up the white mark on the injection knob and the black mark on the body of the pen.
  - b) Hold the GENOTROPIN PEN 5 upright and gently tap the metal front part with your finger to move any air bubbles to the top.
  - c) Push the black/white injection knob all the way in. You will see a drop of liquid appear at the needle point. Any

trapped air has now been released.

- d) If no liquid squirts out, press the red release button and turn the black/white injection knob clockwise (to the right) until it clicks once. Repeat steps b) and c).

- If desired, attach the reusable needle guard over the needle—push until it snaps in place. Again, be careful not to touch the exposed needle. To avoid an accidental needle stick, grip the sides of the needle guard; never push on the end.

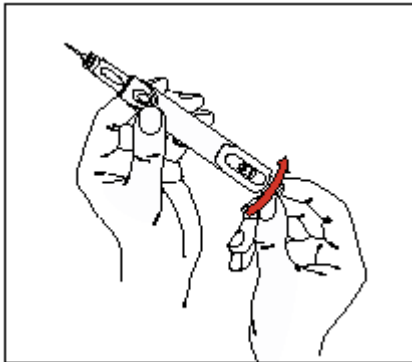

#### **6. Dial Your Prescribed Dose**

- Press the red release button to reset the device.
- The black/white injection knob will pop out and the dose display window will read **0.0**.
- With the dose display activated, turn the black/white injection knob clockwise (to the right) until your prescribed dose is displayed.
- If you go too far, just turn the knob back the other way until the correct dose is displayed.

NOTE: If you turn the black/white injection knob backwards beyond zero after a cartridge has been inserted, the pen display will show (--). Just turn the injection knob forward (clockwise) until numbers reappear on the dose display.

- The GENOTROPIN PEN 5 contains a battery for the dose display. To save the battery's energy, the dose display is activated for two minutes and then automatically disappears. **Although the display is no longer visible, the dose remains available for delivery.**

NOTE: Each click of the black/white injection knob equals a one-tenth-of-a milligram dose (or 0.1 mg). One click—or 0.1 mg—is the minimum possible dose per injection; 20 clicks—or 2.0 mg—is the maximum possible dose per injection. If you accidentally dial more than the maximum 2.0 mg dose, some liquid may emerge from the tip. This is normal and will not affect your injection—simply dial back to the correct dose.

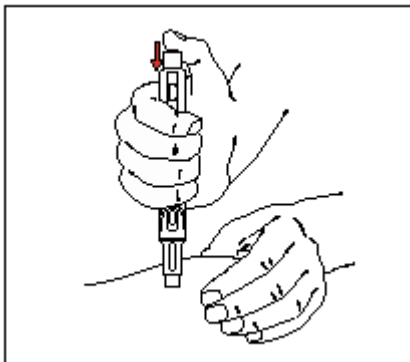

#### **7. Inject your GENOTROPIN**

- Select and prepare an appropriate injection site, as directed by your healthcare provider.
- Pinch a fold of skin at the injection site firmly, and push the GENOTROPIN PEN 5 into the skinfold at a 90° angle. Push the pen down as far as possible.
- Push the black/white injection knob until it clicks. Wait at least 5 seconds and then withdraw the GENOTROPIN PEN 5.

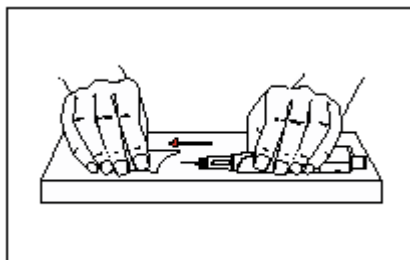

#### **8. Discard the Needle and Store the GENOTROPIN PEN 5**

- Remove and store the needle guard, if you used one.
- **Carefully** replace the outer protective cap on the needle, as instructed by your healthcare provider.
- Unscrew the needle and discard it in a proper disposal container. **NEVER REUSE A NEEDLE.**

- Replace the front cap, then put the GENOTROPIN PEN 5 back in its protective case. Store it in the refrigerator at 2° to 8°C (36° to 46°F) until your next injection.

### **Your Next Injection**

If you already have a drug cartridge in your GENOTROPIN PEN 5, prepare the pen and administer your dose as follows:

- Remove the front cap of the GENOTROPIN PEN 5.
- Remove the paper covering from the back of a new needle.
- Screw the needle onto the metal front part of the pen by turning it clockwise (to the right).
- Remove the outer and inner needle caps.
- Follow the instructions above, starting with step 6.

### **To Replace the Cartridge**

- Press the red release button to reset the GENOTROPIN PEN 5.
- **Turn the black/white injection knob counterclockwise (to the left) as far as it will go.**
- Unscrew the metal front part and remove the empty cartridge.
- Discard the empty cartridge as instructed by your healthcare provider.
- To insert a new cartridge and prepare the GENOTROPIN PEN 5 for use, follow the instructions above.

### **Storage**

Between uses, store your GENOTROPIN PEN 5 in the refrigerator at 2° to 8°C (36° to 46°F) in its protective case. **Always remove the needle** before storing. Do not freeze. Protect from light. Discard the cartridge in your GENOTROPIN PEN 5 within 28 days after reconstitution (mixing of the growth hormone powder with the liquid) even if the cartridge is not empty.

When traveling, keep your GENOTROPIN PEN 5 in its protective case and carry it in an insulated bag to protect it from heat or freezing. Put it back in the refrigerator as soon as possible.

### **Caring For Your GENOTROPIN PEN 5**

No special maintenance is required. To clean the GENOTROPIN PEN 5, wipe the outside surface with a damp cloth. Do not immerse. Do not use alcohol or any other cleaning agents, as they may damage the plastic body.

To clean the reusable needle guard, wipe it with a damp cloth or alcohol swab.

## **COMMON QUESTIONS**

### **How do I tell how much GENOTROPIN is left in the GENOTROPIN PEN 5?**

Look at the dose scale imprinted along the side of the window on the metal front part of the pen. The front edge of the gray rubber plunger lines up with the number of milligrams remaining in the cartridge.

### **What happens when the battery runs low?**

The battery in the GENOTROPIN PEN 5 should run for two years. When it begins to run low due to the end of the battery's life, you will see a flashing symbol (≡) in the dose display. This means the battery will last about another month. When the battery is dead, the dose display will show a steady ≡. A flashing "bt" means the battery is running very low for some other reason and will last for about another month. When the battery is dead, the display will then show a steady "bt".

In either case, call the Pfizer Bridge Program at the toll-free number listed below to exchange your GENOTROPIN PEN 5 for a new one.

### **If the battery suddenly dies, can the GENOTROPIN PEN 5 still be used?**

Yes. Call the Pfizer Bridge Program at the toll-free number listed below for instructions on how to determine the dose without the electronic dose display.

## **Questions about how to use the GENOTROPIN PEN 5?**

**Call the Pfizer Bridge Program toll-free at (800) 645-1280**

Manufactured by:  
Ypsomed AG  
Burgdorf, Switzerland



**Caution:** Federal law restricts this device to sale by or on the order of a physician

LAB-0225-5.0  
Revised October 2008